

Article number: 0101051
 Description: Retaining ring A 34 DIN 471
 Spring steel
 Note: Fitted with ZGA pilers

Measures

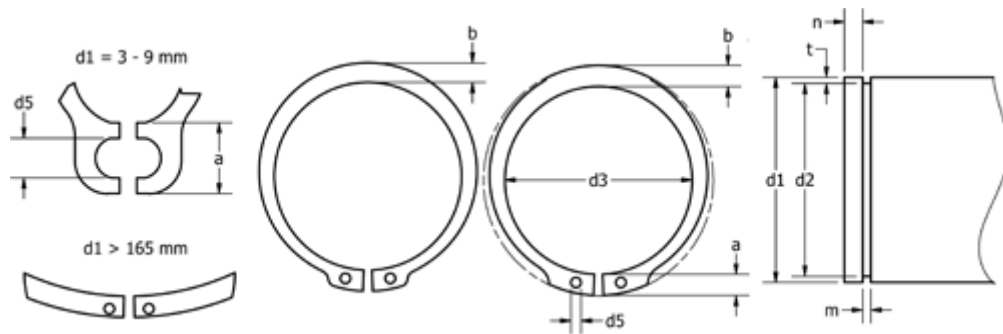

a max	= 5.4	FN kN	= 14.7	s	= 1.50
AN mm ²	= 88.0	FRg kN	= 5.60	t	= 0.85
b	= 3.8	FR kN	= 31.30	tol	= -0.25
d1	= 34	g	= 2.0	tol	= -0.06
d2	= 32.3	K kN-mm	= 61.30	tol	= +0,25-0,50
d3	= 31.5	m min	= 1.60	Tong	= ZGA-2
d5 min	= 2.5	n abl x 1000	= 16.0	Weight kg/1000	= 3.800
Description	= A34	Nominal drive	= 2.6		